

**4K Resolution**  
**15 kHz Blazing Fast Scan Rates**

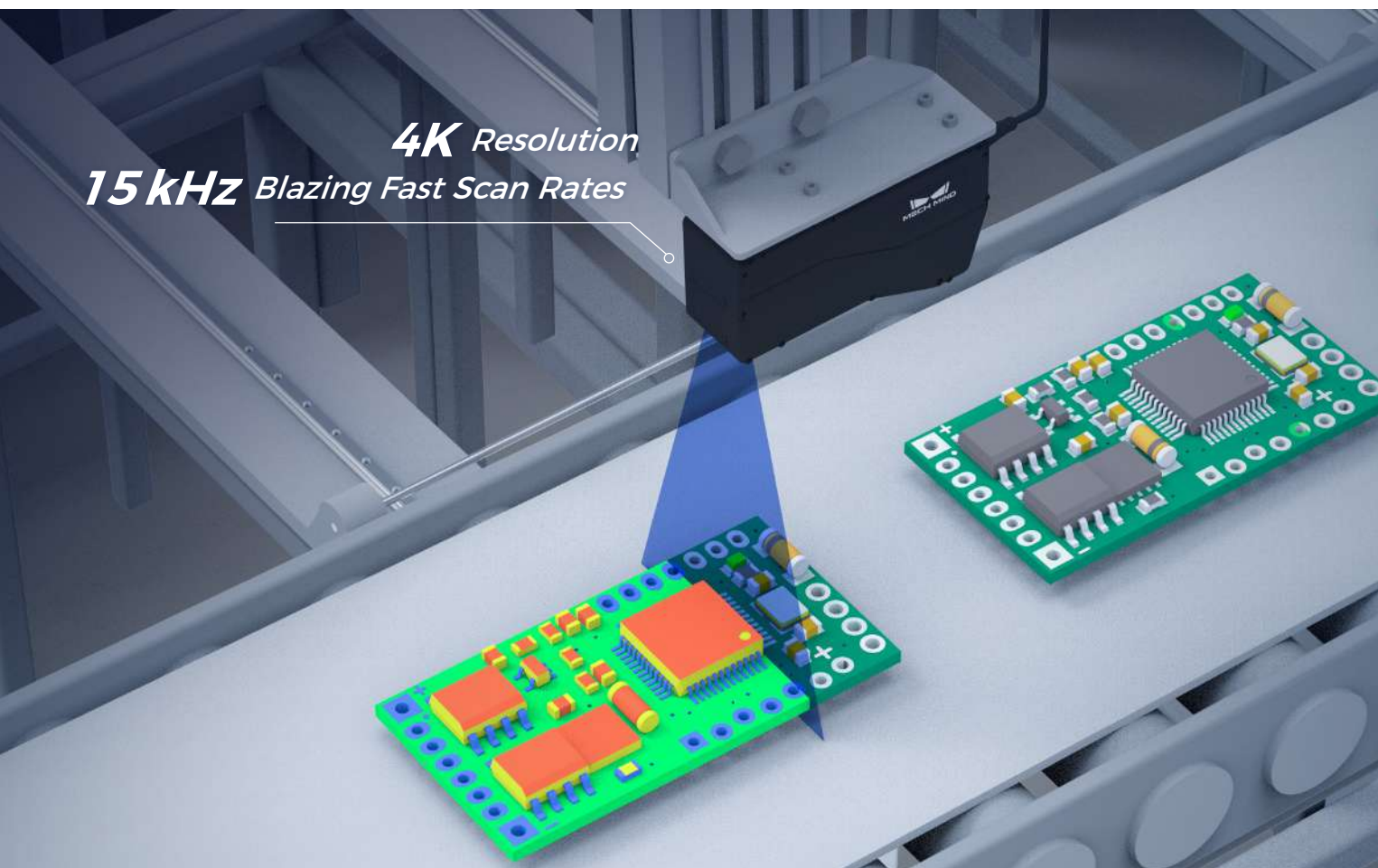

High-Speed 3D Laser Profilers

## **Mech-Eye LNX-8000 Series**

For inline inspection applications in automotive, EV battery, electronics, and other industries.

# 4K+ Resolution Laser Profiling to see every detail and feature

Mech-Eye LNX-8000 series is the new-generation 3D laser profiler with an astounding 4K+ resolution. Leveraging advanced optical design and AI algorithms, the Mech-Eye LNX-8000 produces 4,096 data points per profile for high-resolution 3D inspection of targets (dents, gaps, edges, etc.), even for microscopic features.

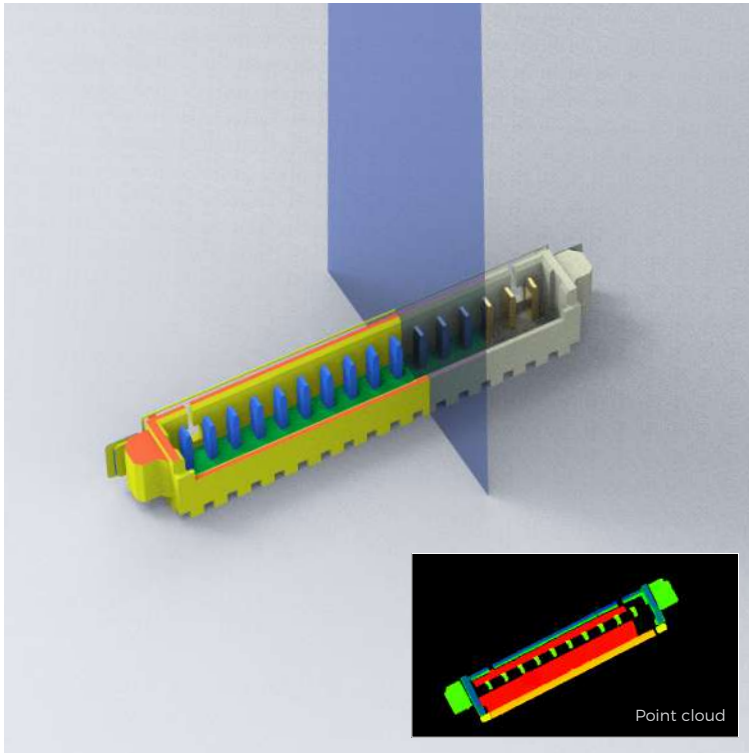

Mech-Eye LNX-8030 scans pins.

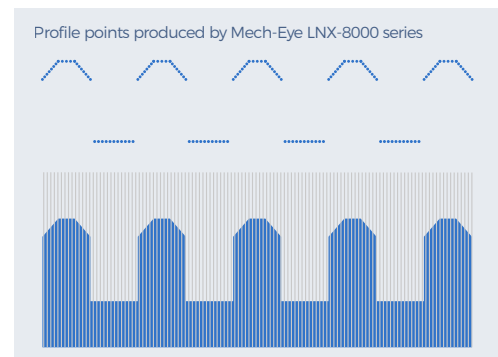
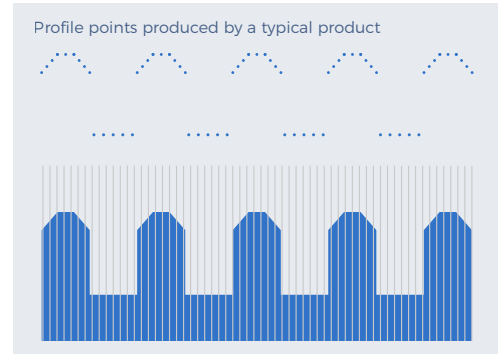

When the X-axis scanning range is constant, the LNX-8000 series generates more profile points than other line profilers.

# Micron Resolution and Precision to inspect microscopic defects

When maintaining a constant scanning range along the X-axis, the Mech-Eye LNX-8000 series outperforms other profilers by providing a higher density of profile points. It achieves an impressive Z repeatability at  $0.2 \mu\text{m}^{[1]}$  and  $\pm 0.02\%$  of F.S. linearity<sup>[1]</sup>. These features enable precise inspection, even on the tiniest details and most complex surfaces.

## Comparison with a typical laser profiler

X-axis (width)			Z-axis (height)		
	typical product	LNX-8030		typical product	LNX-8030
Measurement range	35 mm (RD) <sup>[2]</sup>	35 mm (RD) <sup>[2]</sup>	Repeatability	0.5 $\mu\text{m}$	0.2 $\mu\text{m}$
Data points per profile	3200	4096	Linearity	$\pm 0.03\%$ of F.S.	$\pm 0.02\%$ of F.S.
Profile data interval	12.5 $\mu\text{m}$	9 $\mu\text{m}$			

[1] Applicable to Mech-Eye LNX-8030

[2] Reference distance

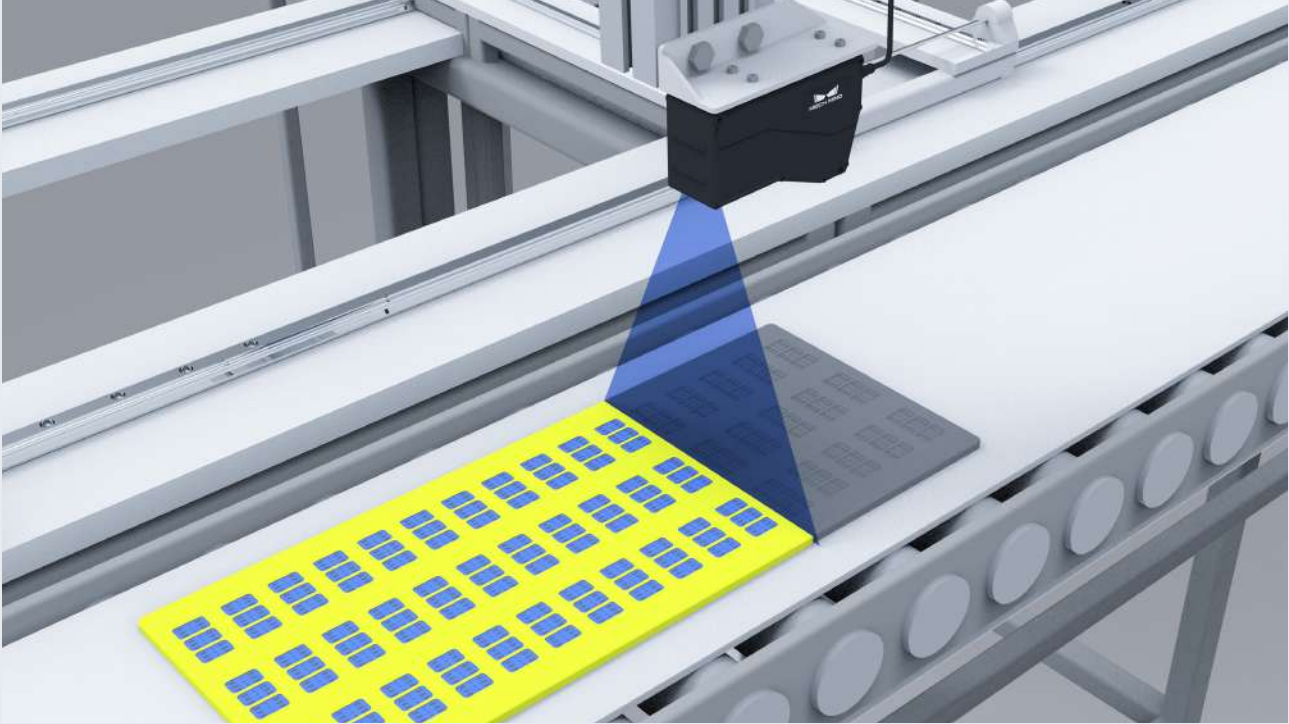

Mech-Eye LNX-8080 scans SIM card slots. It can scan multiple parts in a single capture, boosting production efficiency by over **50%** and significantly increasing production capacity.

## Ultra-High Scan Rates and Large FOVs to scan large parts and edge details at a fast speed

Do more with fast scan rates and large measurement ranges.

- Achieve scan rates of 3.3 kHz (scan of the full field of view) and up to 15 kHz (scan of the complete X measurement range). Generate high-resolution 3D data at an accelerated pace.
- The X measurement range reaches 430 mm<sup>[1]</sup> and the Z measurement range reaches 305 mm<sup>[1]</sup>. Scan large objects in one exposure or multiple small parts simultaneously, significantly boosting inspection speed and keeping up with the production pace.

## Single-Shot HDR to scan dark and reflective surfaces in a single exposure

The Mech-Eye LNX-8000 series, equipped with a single-shot HDR function, makes it possible to scan both dark (low reflectivity) and reflective (high reflectivity) surfaces in one exposure and creates complete 3D point clouds.

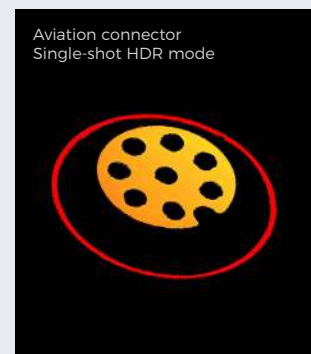
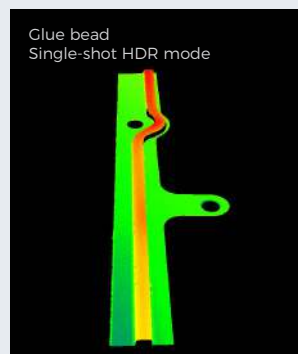
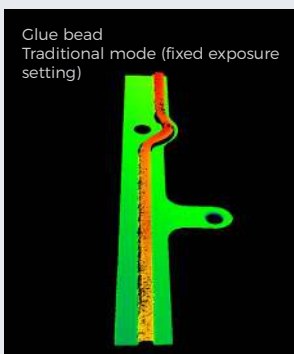

[1] Applicable to Mech-Eye LNX-8300

# Advanced Optical Design and Algorithms

## to measure almost any material and surface

The Mech-Eye LNX-8000 series features an advanced optical design, incorporating a laser with a cylindrical lens, a large-aperture Schmidt lens, and an imaging sensor with a resolution of up to 10MP. These features enable more precise imaging of any surface and intricate detail.

- Our self-developed laser, equipped with a uniquely designed **cylindrical lens**, emits light with a wide field of view and a narrow fan angle, minimizing blind spots effectively.
- A **large-aperture Schmidt lens** enhances received light intensity fourfold compared to conventional lenses. Its high-resolution, low-distortion design significantly improves imaging quality.
- With up to **10MP** resolution, the CMOS provides 4,096 data points per profile, enabling precise measurement of even the most intricate features.

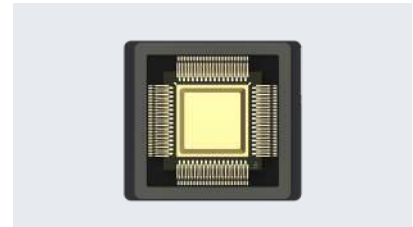
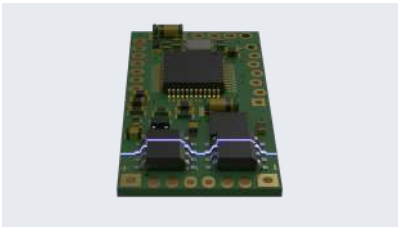

### ▼ Point clouds: pin tip

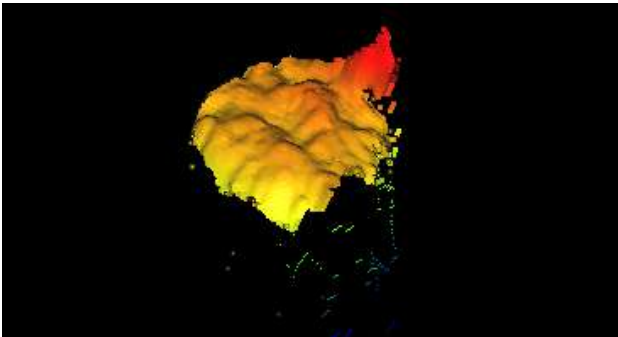

The point cloud generated by a conventional 3D line laser profiler has visible noisy data, like spikes, that can affect measurement accuracy.

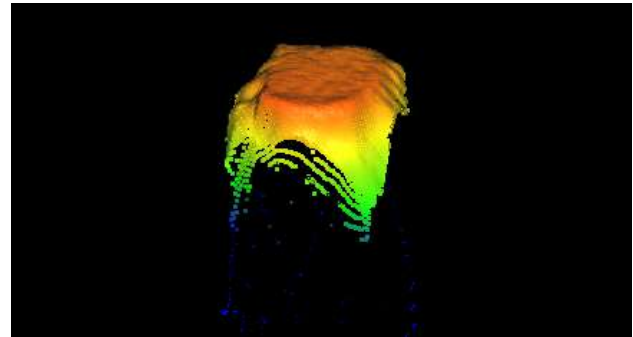

The Mech-Eye LNX-8000 series adopts high-resolution CMOS and advanced optical designs, allowing precise imaging of even the smallest pin tips.

With our **robust algorithms**, the Mech-Eye LNX-8000 series excels in handling **interreflection, dead zones, and other challenging situations**. Its enhanced resistance to interference ensures precise and reliable measurement results.

### ▼ Point clouds: BCA

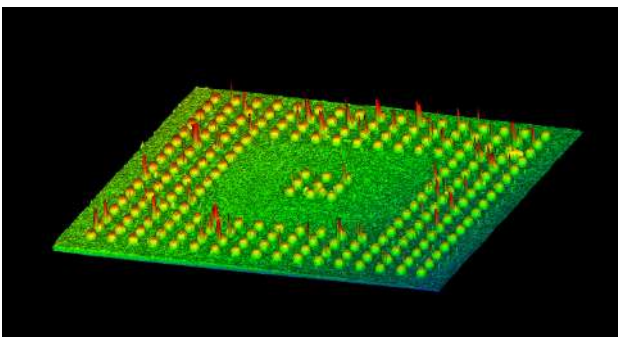

Traditional algorithms struggle with interference caused by interreflection. This results in point cloud outliers that affect measurement accuracy.

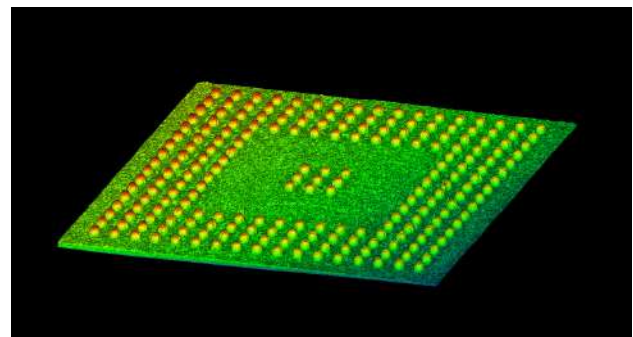

Robust anti-interreflection algorithms eliminate outliers and deliver high-quality point clouds, ensuring reliable measurement results.

# Choose from a lineup tailored to your application needs

The Mech-Eye LNX series introduces multiple models to enhance quality control and process optimization across diverse industries.

Work with Mech-MSR 3D Measurement and Inspection Software and Mech-DLK Deep Learning Software to help you rapidly deploy measurement/inspection applications

Develop your applications using multi-language SDK, including C++ and C#; Easily connect to HALCON and other third-party vision software through the native API or GenICam/CigE interface

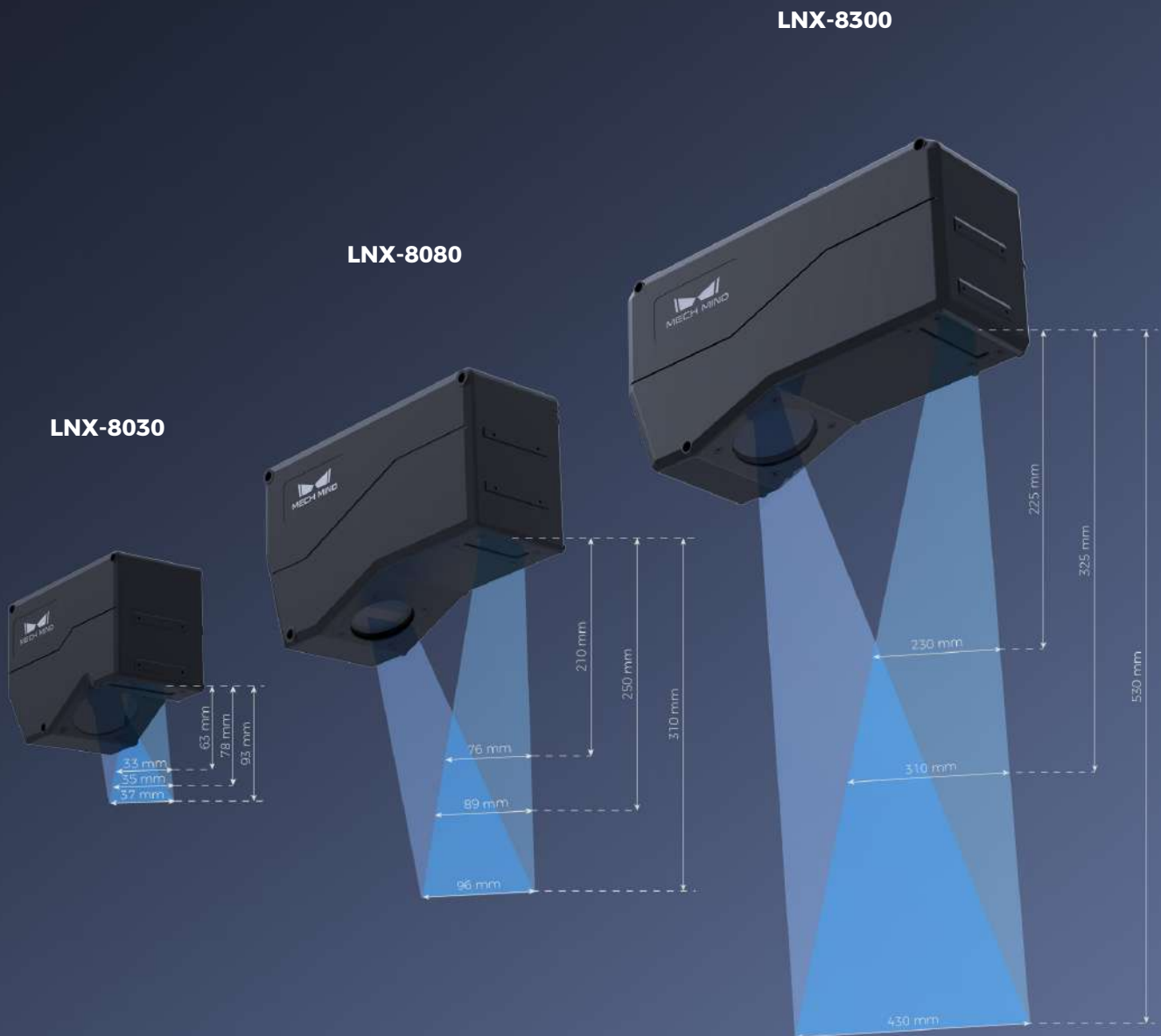

# Applications in the Consumer Electronics

## Solder Joint Inspection

### ► The challenge

- Solder joints are tiny, typically ranging from tens to hundreds of micrometers in height.
- Solder joints have reflective surfaces, making precise 3D scanning and inspection more challenging.
- The shapes of the joints are highly varied and irregular, including spherical, conical, cylindrical, and other forms.

### ► The advantage

- Generate high-resolution 3D data (**4,096** data points per profile and Z repeatability down to **0.2 μm**) of each solder joint.
- Advanced algorithms effectively handle the reflection and generate **detailed and high-density 3D data**.
- **Mech-DLK** deep learning software strategically used to segment and recognize different sold joint types.

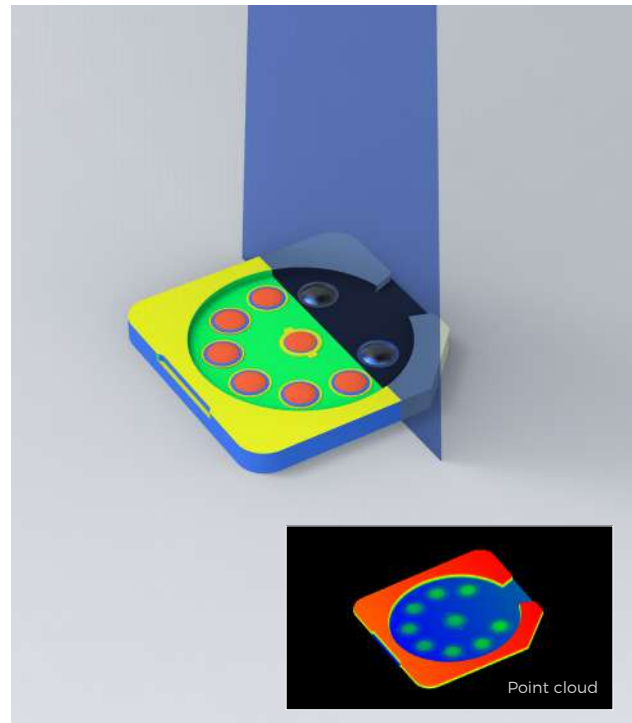

## Pin Height Measurement

### ► The challenge

- Pins are difficult to scan and measure because they are tiny, highly reflective, and come in varying heights and materials.
- Noise, such as spikes, in the 3D data regularly appears between pins.
- Pins of slightly incorrect height can result in short circuits and poor contact.

### ► The advantage

- Generate high-resolution 3D data (**4,096** data points per profile) of each tiny, highly reflective pin.
- Advanced optical design and algorithms effectively handle different types of noise, such as dead zones and spikes.
- **Micron resolution** to measure the pin's height precisely and accurately.

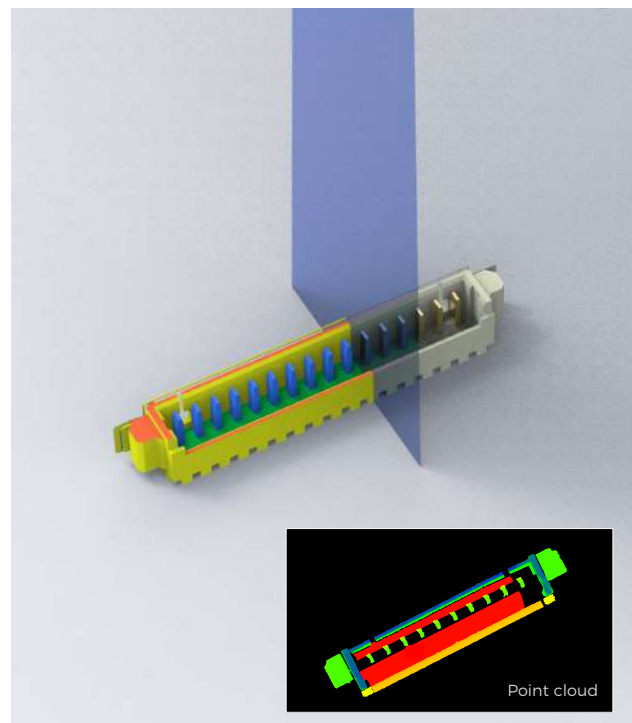

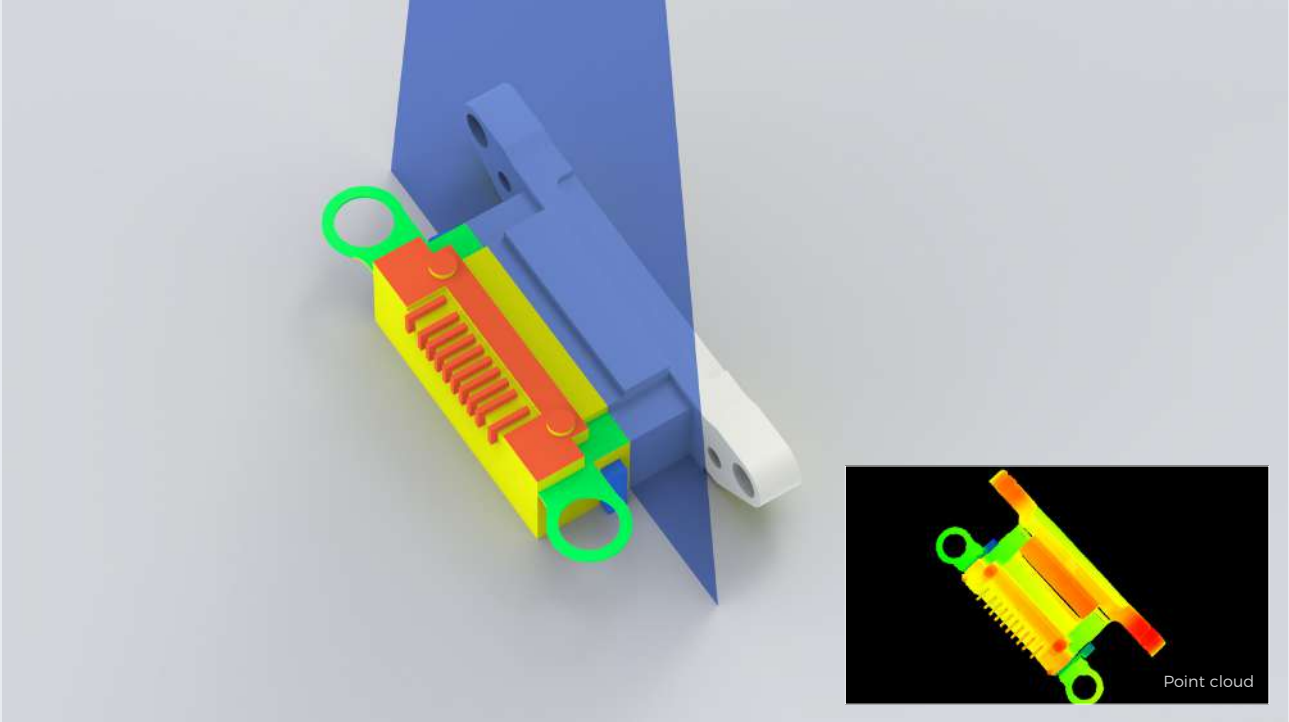

## Card Edge Connector Coplanarity Inspection

### ► The challenge

- The light reflected from the metal coating impacts the inspection result.
- Complex surfaces and tiny features (e.g., grooves, protrusions, and patterns) pose challenges to the imaging.
- A moving production line requires quick and consistent inspection.

### ► The advantage

- Create a high-resolution image by scanning each reflective pin in high density (4,096 points/profile).
- Measure targets at ultrahigh scanning speeds and produce stable profiles for **efficient and consistent inspection**.
- Advanced imaging algorithms handle dead zones and reflection for accurate results.

## More Applications

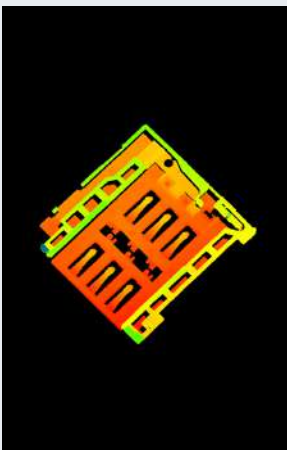

SIM card holder height measurement

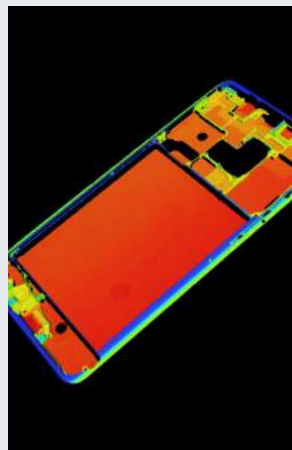

Cellphone midplate inspection

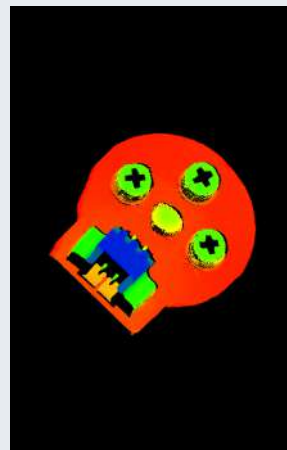

Screw height measurement



Shielding frame inspection

# Applications in the EV Battery

## Sealing Pin Welding Inspection

### ► The challenge

- Tiny pin welds require high inspection accuracy.
- Some defects occur on the pin welds, such as burns, dents, pinholes, broken and missing welds.
- Fast and stable scanning is required in the process to avoid line shutdowns and maximize yields.

### ► The advantage

- High-speed and high-quality imaging of tiny welds for accurate and efficient inspection.
- **Pixel-level defect segmentation** and inspection with robust algorithms.
- Stable and durable operation for efficient production and high productivity.

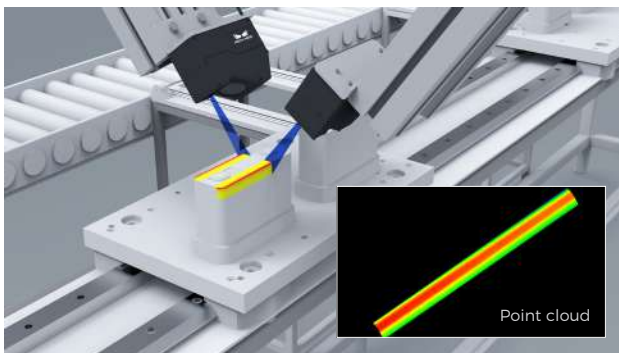
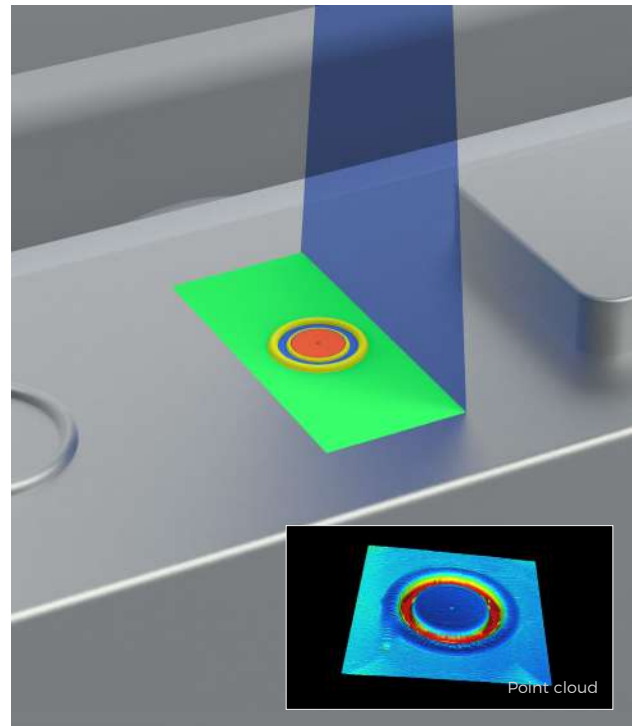

Cap welding inspection

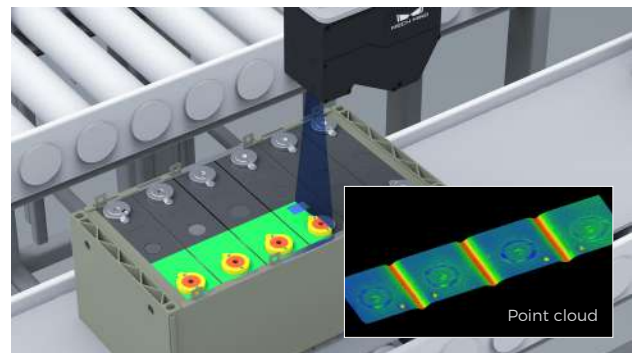

Busbar welding inspection



Height measurement of battery cell

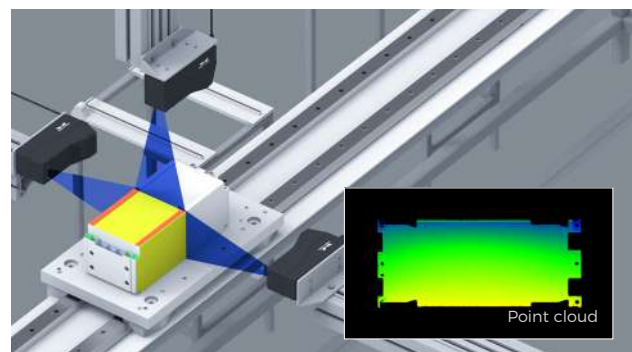

Dimensional measurement of battery module



# Applications in the Automotive Industry

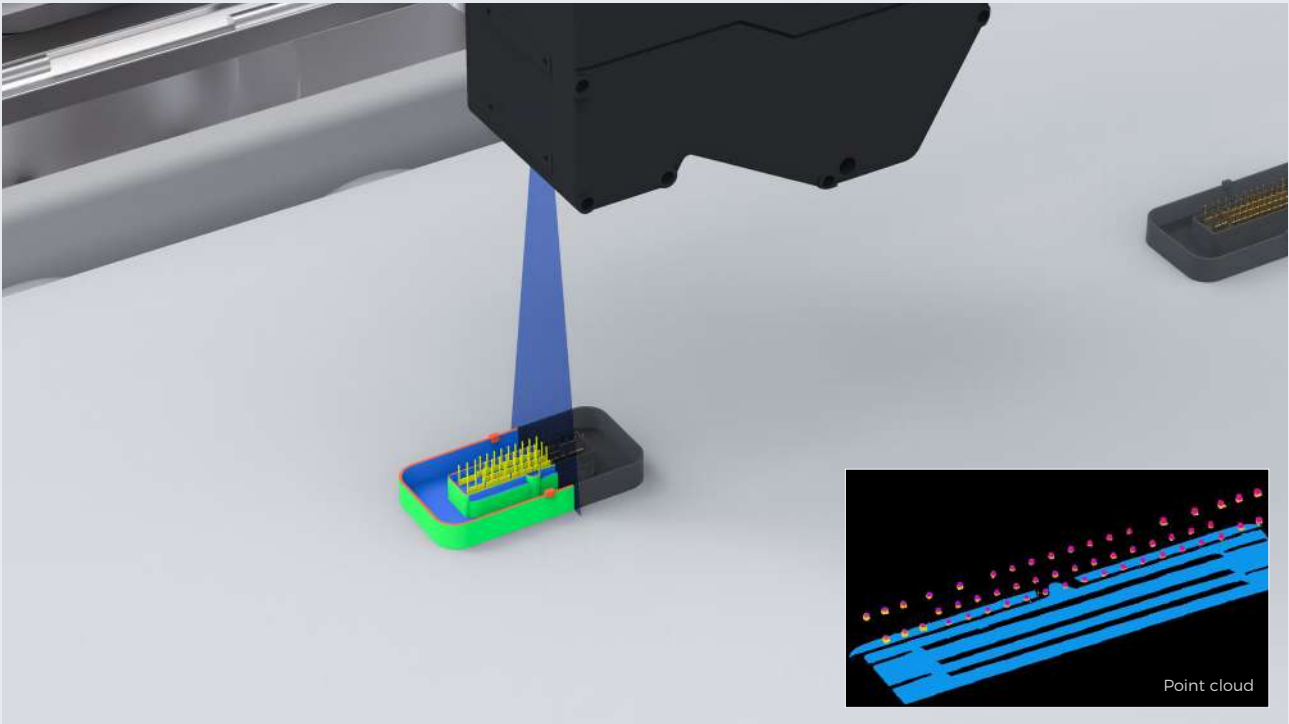

## Connector Pin Inspection

### ► The challenge

- Pins of slightly incorrect height can result in voltage drops and intermittency.
- The tiny pin inspection places high demands on accuracy and resolution.
- Noise resulting from interreflection between pins impacts the image quality.
- Intricate geometries of pins are easy to create curves in the 3D point clouds.

### ► The advantage

- Produce **high-density and high-resolution profiles** and detailed 3D point clouds of tiny pins.
- The robust algorithms effectively deal with the noisy data resulting from reflection.
- Advanced algorithms and AI-powered tools precisely measure the height of the pins and separate the curved point clouds.

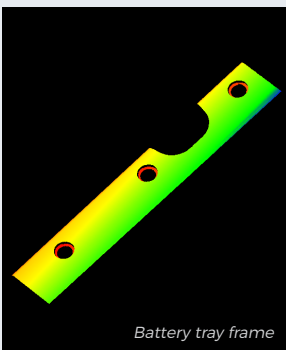

Battery tray frame

EV battery tray inspection

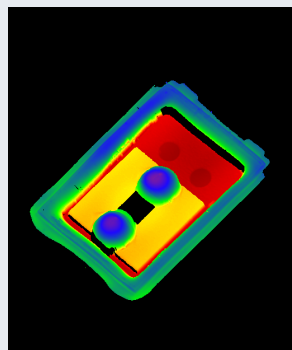

Glue bead inspection

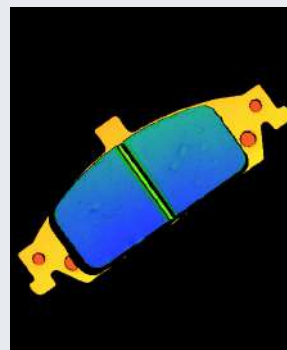

Brake pad defect detection

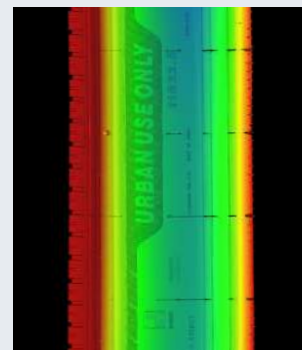

Tire DOT code reading

# Applications

## in semiconductor, pharmaceutical, metal and more industries

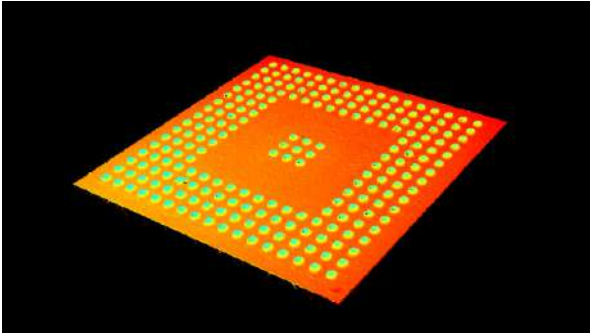

BGA inspection (height, coplanarity, etc.)

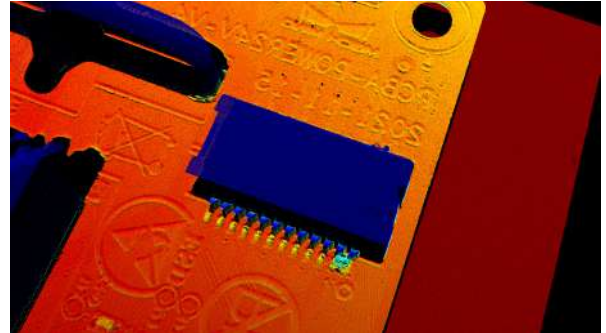

PCB solder paste inspection

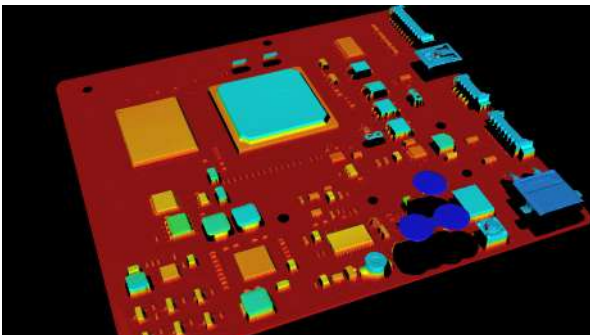

Height measurement of PCB-mounted parts

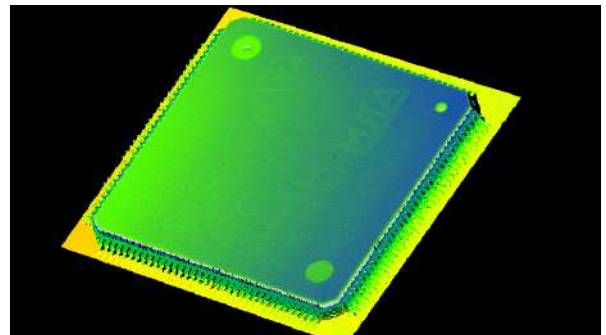

Chip welding inspection

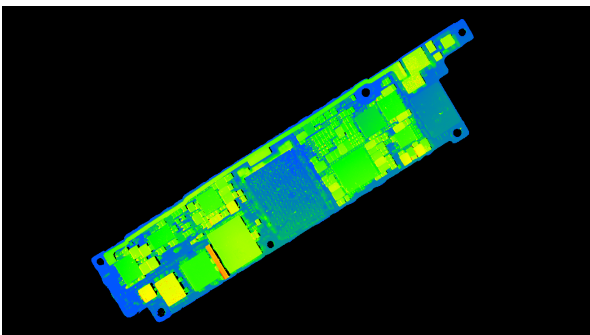

Part presence/absence detection

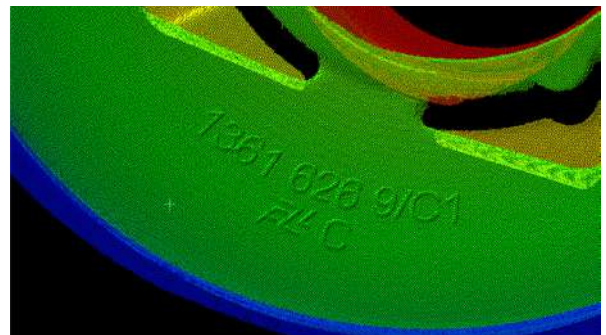

Character recognition on cast surfaces

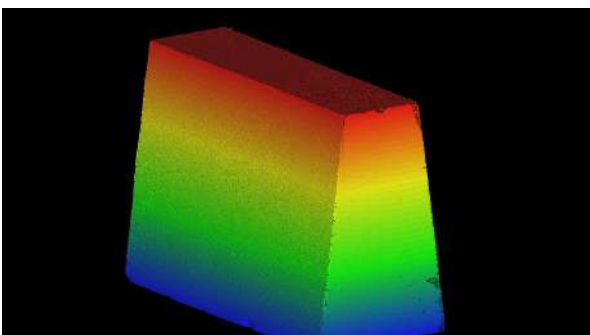

Refractory brick dimensional measurement

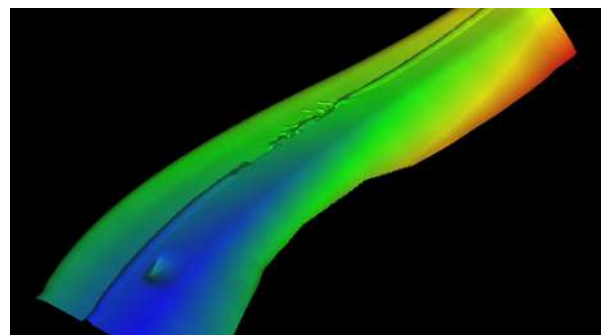

Welding seam inspection

# Mech-Eye LNX-8000 Series and Key Specs

Specification	LNX-8030	LNX-8080	LNX-8300
Data points/profile	4096		
Reference distance (RD)	78 mm	250 mm	325 mm
Measurement range Z	30 mm	100 mm	305 mm
Measurement range X (near/RD/far)	33/35/37 mm	76/89/96 mm	230/310/430 mm
Resolution X	9 $\mu$ m	23.5 $\mu$ m	105 $\mu$ m
Repeatability Z	0.2 $\mu$ m	0.5 $\mu$ m	2 $\mu$ m
Linearity Z	$\pm$ 0.02% of F.S.		
Scan rate	3.3-15 kHz		
Dimensions	133 x 61 x 102 mm	182 x 63 x 112 mm	195 x 61 x 109 mm
Weight	0.9 kg	1.2 kg	1.2 kg
Laser	Blue (405 nm, Class 2)	Blue (405 nm, Class 2M)	Blue (405 nm, Class 2M)
Lens inclination	30°	22°	19°
Input voltage	24V DC		
Max. input power	48W (25W for sensor head)		
Communication interface	Gigabit Ethernet		
Encoder input	Single-ended and differential encoders supported		
Operating temperature	0-45°C		
Safety and EMC	CE/FCC/VCCI/KC/ISED/NRTL		
IP rating	IP67		
Cooling	Passive		

Mech-Eye LNX-8030

Mech-Eye LNX-8080

Mech-Eye LNX-8300

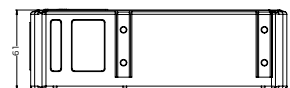
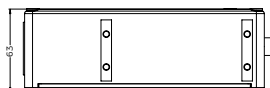
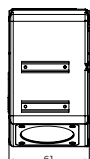
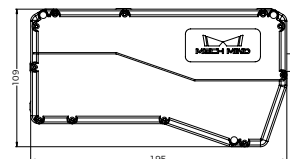
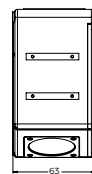
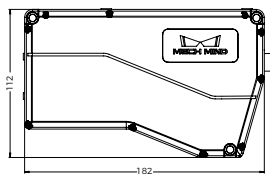
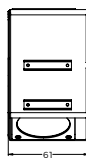
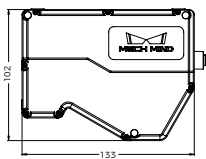

Unit: mm

**3D VISION & AI FOR ROBOTS AND MORE**

---



Mech-Mind Robotics Technologies Ltd.

Website: [www.mech-mind.com](http://www.mech-mind.com)

E-mail: [info@mech-mind.net](mailto:info@mech-mind.net)

---